



RH TEEN

HOPPER MEDIA ARMOIRE

FURNITURE ASSEMBLY INSTRUCTIONS

PARTS INCLUDED

NO.	ITEMS	DESCRIPTIONS	QTY.
1.		IRON BARS	4
2.		IRON SHELF	2

ASSEMBLY INSTRUCTIONS

1. Care fully unpack the contents of the cartoon.
2. Place the removable self near Armoire.
3. To use bars given in the cartoon and put them in the Armoire To use
4. Put the removable self (as required) into the Armoire.

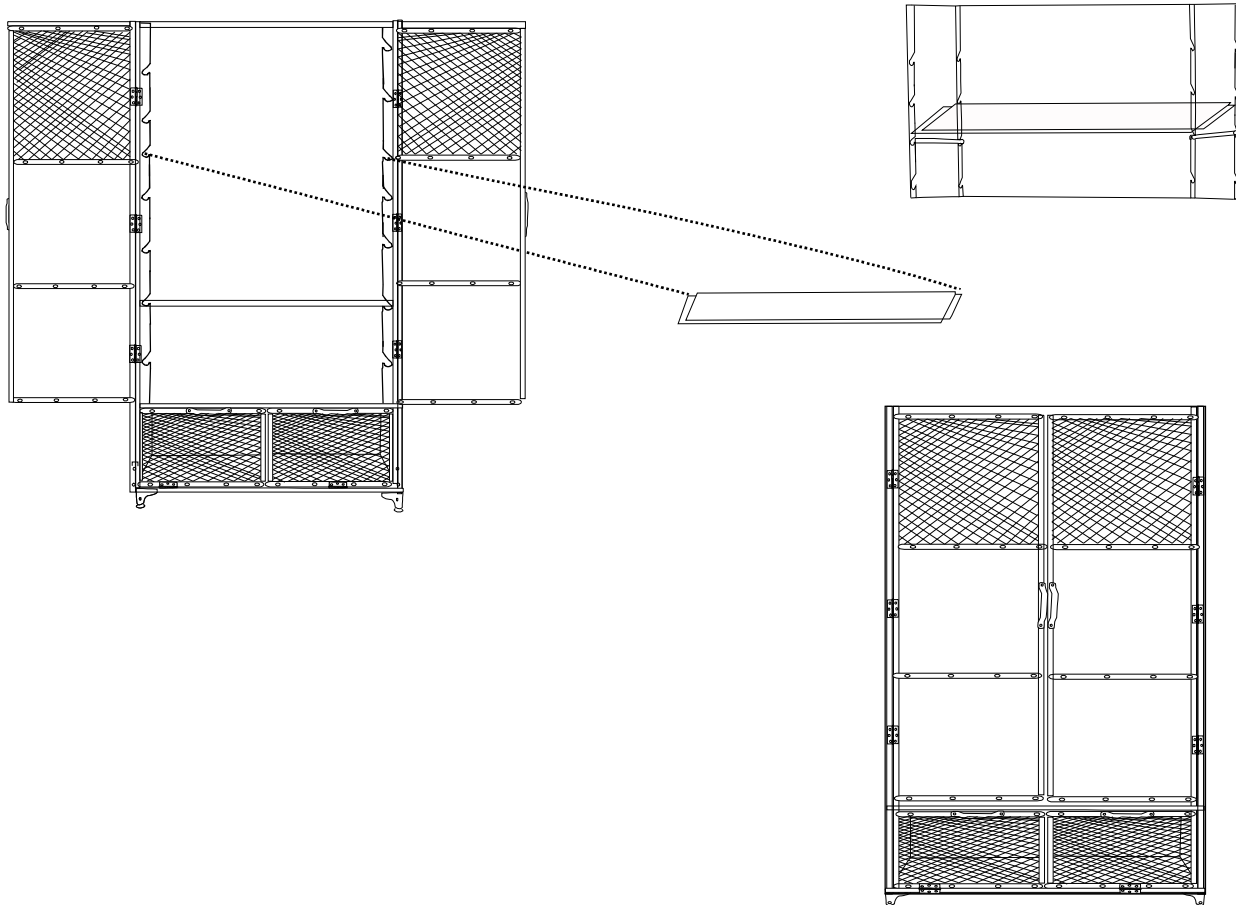

CARE INSTRUCTIONS

1. DO not use abrasive cleaner , chemical cleaner , or metal polishes. the Armoire has a protective lacquer finish that could be damaged by chemicals or abrasive cleaning agent

RHTEEN







HOPPER MEDIA ARMOIRE

PARTS INCLUDED:

A complete kit contains 1 sets of the following

ASSEMBLY INSTRUCTIONS

Professional installation recommended

NO.	ITEM	DESCRIPTION	QTY
1		Screw-0.75"	2 PCS.
2		Screw-1.5"	2 PCS.
3		Steel cable	1 PCS.
4		Steel Brackets	2 PCS.
5		Mini Anchors	2 PCS.
6		Wall Anchor	2 PCS.
7		Self Drill Screw	2 PCS.

1. Tighten the metal bracket on to the wall and furniture piece with the help of the screw given. For dry wall Fixing, mini anchors are to be used along with the screws.
2. Tighten the steel cable (3) on to the brackets (4) on the wall and on the product as shown below.
3. Tighten the cord grip as required and adjust the spacing with the wall accordingly.

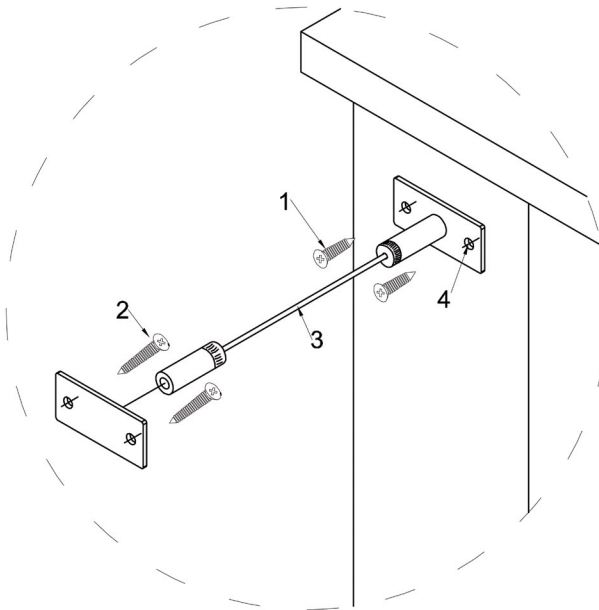

WARNING

Serious or fatal crushing injuries can occur from furniture tip-over. To help prevent tip-over:

- Place heaviest items in the lowest drawers
- Do not set TVs or other heavy objects on the top of this product
- Never allow children to climb or hang drawers, doors, or shelves.
- Never open more than one drawer at a time.

Use of tip-over restraints may only reduce, but not eliminate, the risk of tip-over.