

RHBABY&CHILD

RHTEEN

OLIN WRITING DESK ANTI-TIP KIT – ASSEMBLY INSTRUCTIONS

PARTS INCLUDED:

A [1] WRITING DESK

TOOLS NEEDED:



PHILLIPS SCREWDRIVER (NOT INCLUDED)

ANTI-TIPPING RESTRAINT:





YOUNG CHILDREN MAY BE INJURED BY TIPPING FURNITURE. THE USE OF AN ANTI-TIPPING RESTRAINT IS HIGHLY RECOMMENDED. WHEN PROPERLY INSTALLED, THIS RESTRAINT CAN PROVIDE PROTECTION AGAINST THE UNEXPECTED TIPPING OF FURNITURE DUE TO SMALL TREMORS, BUMPS OR CLIMBING. **WE RECOMMEND ATTACHMENT TO A WALL STUD WHEN POSSIBLE, OR INSTALLATION BY A PROFESSIONAL WHEN ATTACHING THE ANTI-TIP KIT TO MASONRY OR A CONCRETE WALL.**

WARNING:

THE ANTI-TIPPING RESTRAINT IS ONLY A DETERRENT. IT IS NOT A SUBSTITUTE FOR PROPER ADULT SUPERVISION.

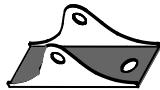
ASSEMBLY INSTRUCTIONS:

1. ATTACH ONE METAL BRACKET (1) TO THE DESK (A) AND THE OTHER TO THE WALL USING THE SCREWS PROVIDED (3, 4).

NO.	ITEM	DESCRIPTION	QTY.
1		Metal Bracket	2 pcs.
2		Clevis Pin	2 pcs.
3		Long Screws 8 x 37mm	2 pcs.
4		Short Screws 8 x 16mm	2 pcs.
5		Hair Pin	2 pcs.
6		Galvanized Steel Cable 1.6 x 162mm	1 pc.

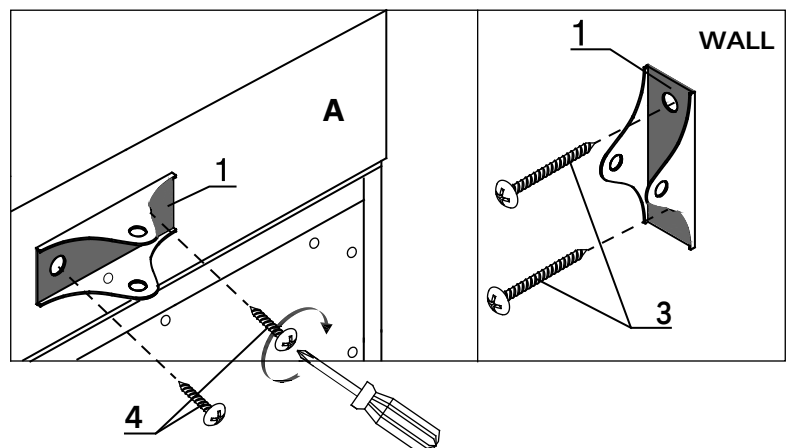

RHBABY&CHILD

RHTEEN

OLIN WRITING DESK ANTI-TIP KIT – ASSEMBLY INSTRUCTIONS

2. PLACE EACH END OF THE STEEL CABLE (6)
INSIDE THE MIDDLE OF EACH METAL
BRACKET (1) AND SLIDE THE CLEVIS PIN (2)
THROUGH THE HOLES IN THE METAL
BRACKET AND STEEL CABLE HEAD.

3. INSERT HAIR PIN (5) INTO THE HOLE IN
THE CLEVIS PINS (2).

4. USE THE ADJUSTABLE LEVELERS ON
THE BOTTOM OF THE DESK WHEN
THE DESK IS PLACED ON AN UNEVEN
FLOOR.

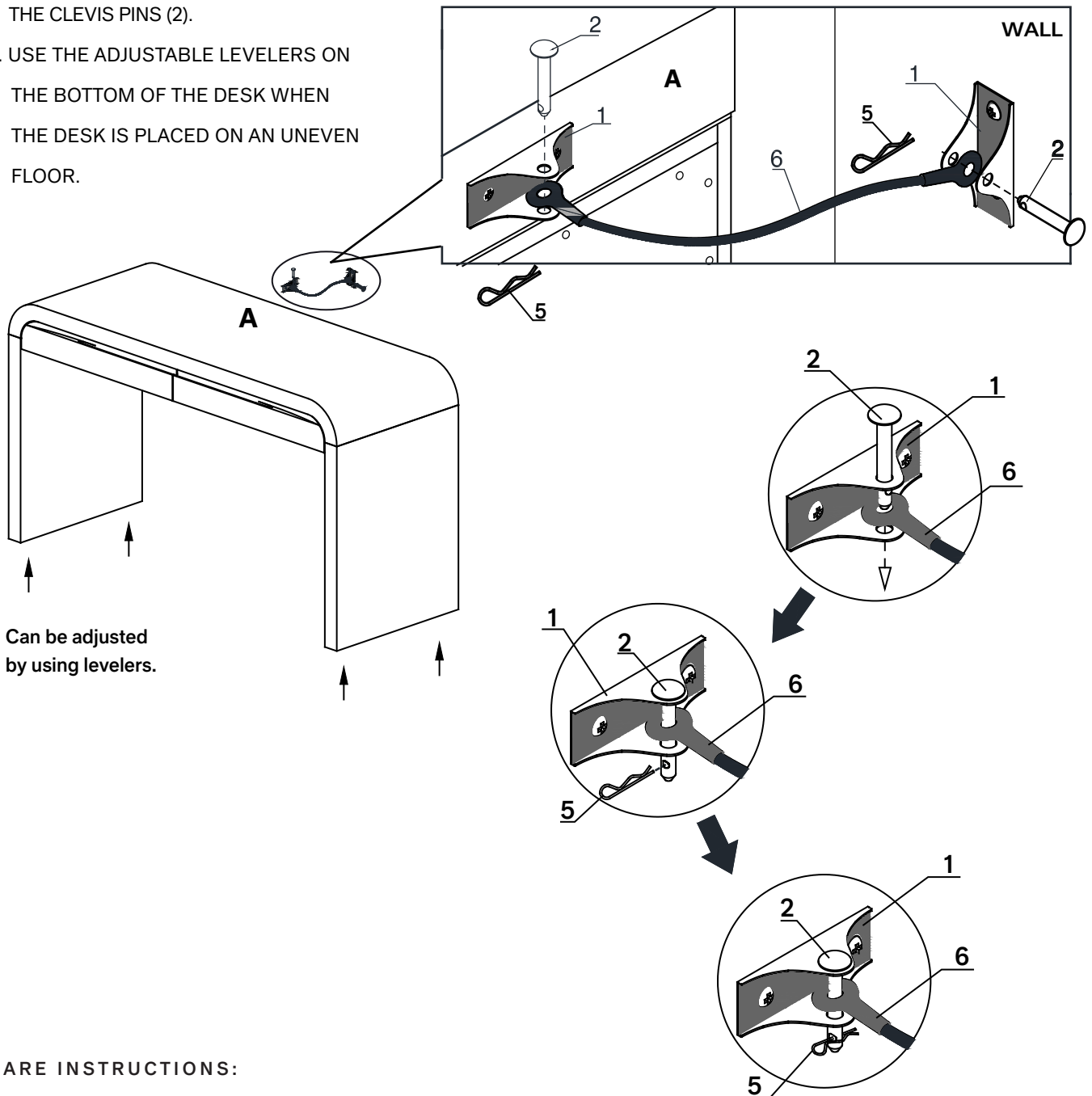

CARE INSTRUCTIONS:

1. DUST OFTEN USING A CLEAN, SOFT, DRY AND LINT-FREE CLOTH.
2. BLOT SPILLS IMMEDIATELY AND WIPE WITH A CLEAN, DAMP CLOTH.
3. DO NOT USE CHEMICAL CLEANERS, ABRASIVES, OR FURNITURE POLISH ON THE LACQUERED FINISH.