

# RH TEEN

## LAGUNA 6-DRAWER STORAGE BED

### PARTS INCLUDED

- A [1] HEADBOARD
- B [2] BED STORAGE
- C [1] FOOTBOARD
- D [1] COVER PANEL

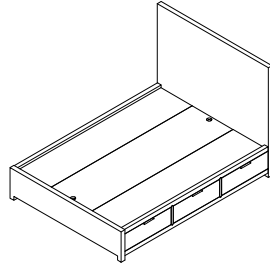

### ASSEMBLY INSTRUCTIONS

1. Place the headboard (A) upright in the position you wish the bed to be in when fully assembled. Remove all the drawers out of the bed storage (B). Put the bed storage (B) up against the headboard (A).
2. Attach the bed storage (B) to the headboard (A) by using Allen bolt (1), lock washer (2) and flat washer (3) as illustrated on Figure 01 and Figure 02.
3. Repeat the above procedure to connect the other bed storage (B) to the headboard (A) and then repeat to connect the bed storage (B) to the footboard (C).
4. Re-insert all the drawers to the bed storage (B). Place the cover panel (D) on the bed storage (B).
5. Assembly is complete.





NO.	ITEM	DESCRIPTION	QTY.
1		Allen Bolt	16 pcs.
2		Lock Washer	16 pcs.
3		Flat Washer	16 pcs.
4		Allen Wrench	1 pc.

FIGURE 02

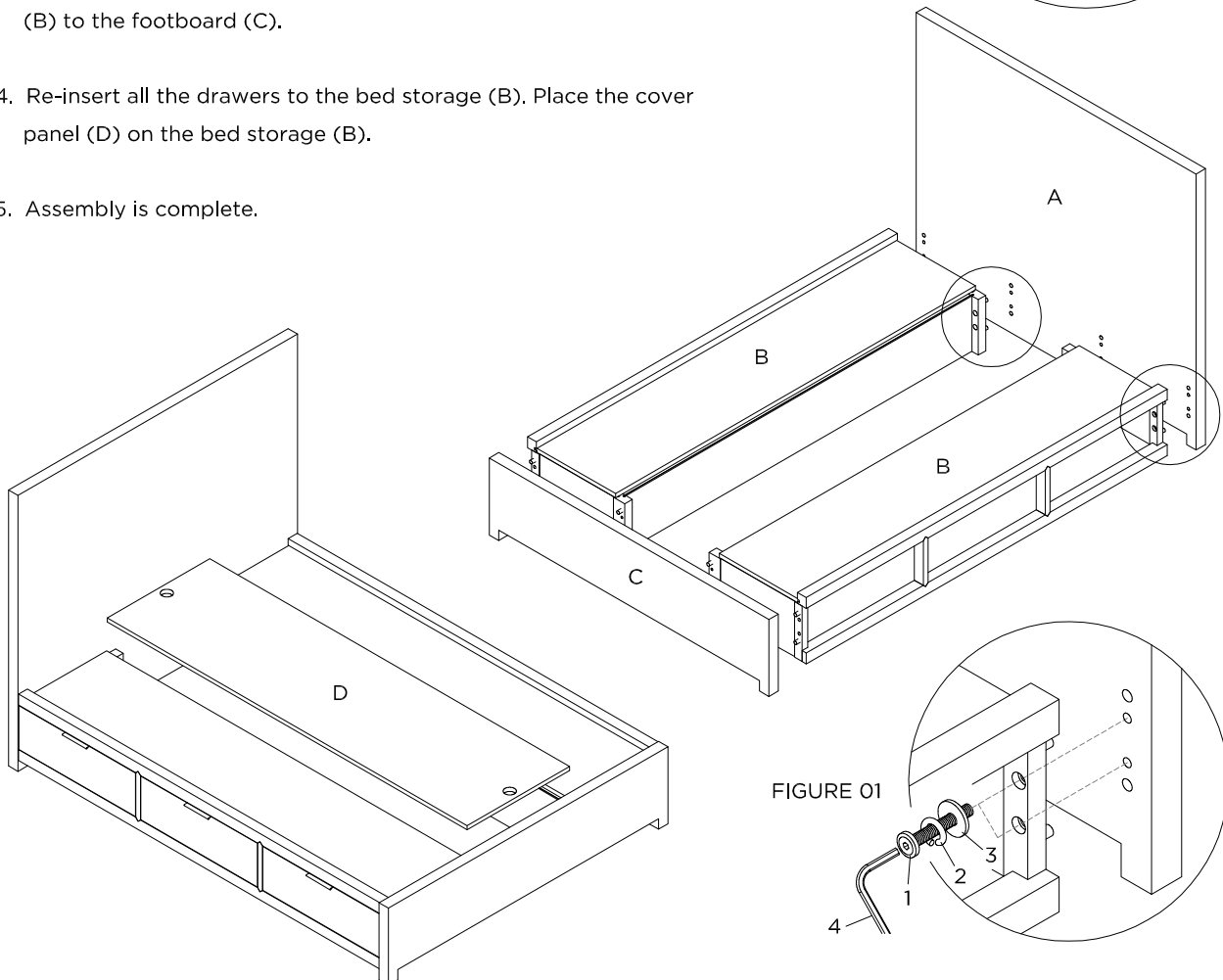
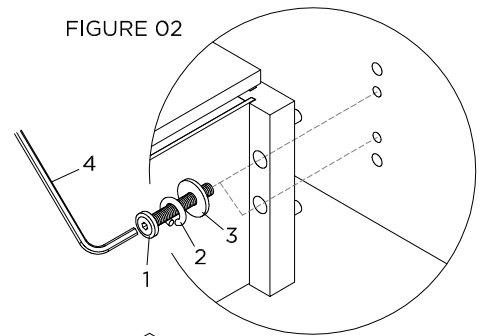

FIGURE 01