

RH BABY & CHILD

CALLUM MEDIA BOOKCASE INSTRUCTIONS





PARTS INCLUDED:

A [1] MEDIA BOOKCASE
B [2] WOODEN SHELF

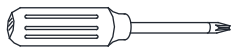
TOOLS NEEDED:

Phillips Head Screwdriver (not included)



NO.	ITEM	DESCRIPTION	QTY.
1		Plastic anchors	4 pcs.
2		Plastic brackets	4 pcs.
3		Restraint straps	2 pcs.
4		Phillips screws M4 x 30mm	4 pcs.
5		Phillips screws M4 x 20mm	4 pcs.

ASSEMBLY INSTRUCTIONS:

Note: Remove the screws from the shelf clips to adjust the placement of wooden shelves.

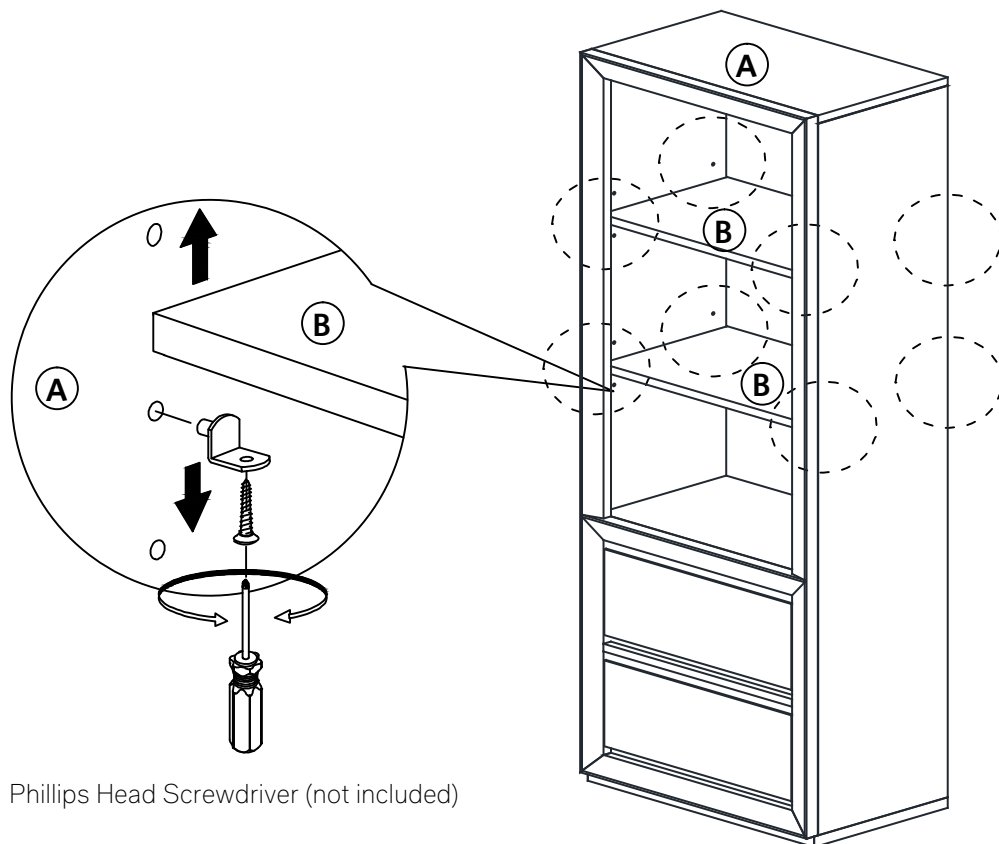

FURNITURE TIPPING RESTRAINT:

Young children may be injured by tipping furniture and the use of a tipping restraint is highly recommended. When properly installed, this restraint could provide protection against the unexpected tipping of furniture due to small tremors, bumps or climbing. We recommend mounting this restraint to a wall stud.

WARNING:

This product is only a deterrent. It is not a substitute for proper adult supervision.

ASSEMBLY INSTRUCTIONS:

1. Attach one of the mounting brackets near the top back edge of the furniture piece by inserting the shorter screws.
2. Determine the final position of the furniture piece. Mark location on the wall approximately 2" below the bracket mounted to the back of the furniture.
3. Drill a starter hole into the wall stud. If wall stud is not available, drill a hole into the wall and insert plastic anchor. Gently tap the anchor until the flange of the anchor is flush with the wall.
4. Attach the second bracket by inserting the longer screw through the bracket and into the wall.
5. Place the furniture so the bracket on the back edge is in line with the bracket in the wall.
6. Lace one end of the nylon restraint strap down through each bracket. Bring both ends together and slide the beaded end until it snap locks into the keyhole slot.
7. To double lock; return the beaded end back through the keyholes as shown.
8. Check to make sure the Restraint strap is securely laced and locked to the brackets.
9. To adjust the wooden shelf, remove the wood screws from under the shelf pegs.

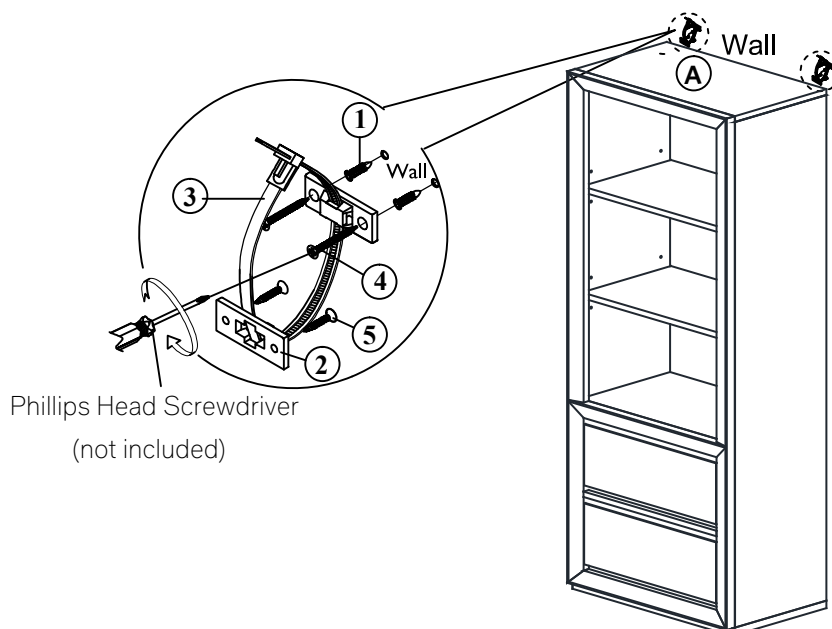

CARE INSTRUCTIONS:

1. Dust often using a clean, soft, dry lint-free cloth.
2. Blot spills immediately, and wipe with a clean, damp cloth.
3. We do not recommend the use of chemical cleansers, abrasives, or furniture polish on our lacquered finish.